



PlayStation

TM

NTSC U/C

PlayStation™

NBA SHOOTOUT 98



EVERYONE



CONTENT RATED BY
ESRB

SCUS-94171
94171



SONY



COMPUTER
ENTERTAINMENT

WARNING READ BEFORE USING YOUR PlayStation™ GAME CONSOLE.

A very small percentage of individuals may experience epileptic seizures when exposed to certain light patterns or flashing lights. Exposure to certain patterns or backgrounds on a television screen or while playing video games, including games played on the PlayStation game console, may induce an epileptic seizure in these individuals. Certain conditions may induce previously undetected epileptic symptoms even in persons who have no history of prior seizures or epilepsy. If you, or anyone in your family, has an epileptic condition, consult your physician prior to playing. If you experience any of the following while playing a video game — dizziness, altered vision, eye or muscle twitches, loss of awareness, disorientation, any involuntary movement, or convulsions — IMMEDIATELY discontinue use and consult your physician before resuming play.

WARNING TO OWNERS OF PROJECTION TELEVISIONS

Do not connect your PlayStation game console to a projection TV without first consulting the user manual for your projection TV, unless it is of the LCD type. Otherwise, it may permanently damage your TV screen.

HANDLING YOUR PLAYSTATION DISC:

- This compact disc is intended for use only with the PlayStation game console.
- Do not bend it, crush it, or submerge it in liquids.
- Do not leave it in direct sunlight or near a radiator or other source of heat.
- Be sure to take an occasional rest break during extended play.
- Keep this compact disc clean. Always hold the disc by the edges and keep it in its protective case when not in use.
- Clean the disc with a lint-free, soft, dry cloth, wiping in straight lines from the outer edge. Never use solvents or abrasive cleaners.

NBA ShootOut '98 Tips and Hints

PlayStation™ Hint Line

Hints for all games produced by SCEA are available:

Within the US: 1-900-933-SONY (1-900-933-7669)

\$0.95/ min. auto hints, \$1.40/ min. live, \$6.95-\$16.95 for tips by mail (subject to availability) & \$5.00-\$20.00 for card recharge

Within Canada: 1-900-451-5757

\$1.50/ min. auto hints

For US callers, game counselors are available 8AM-5PM PST, M-F. Automated support is available 24 hours a day, 7 days a week.

In Canada, automated support is available 24 hours a day, 7 days a week. Live support for Canada is not available at this time.

This hint line supports games produced by Sony Computer Entertainment America. No hints will be given on our Consumer Service Line. Callers under 18 years of age, please obtain permission from a parent or guardian before calling. This service requires a touch-tone phone.

Consumer Service/Technical Support**1-800-345-SONY (7669)**

Call this number for help with technical support, installation or general questions regarding the PlayStation™game console and its peripherals. Representatives are available Monday-Friday, 8AM-6PM Pacific Standard Time.

PlayStation On-Line**<http://www.playstation.com>**

Our news is always hot! Visit our website and find out what's happening — new titles, new products and the latest information about the PlayStation™game console.

Table of Contents

PLAYSTATION SETUP2
CONTROLLER DIAGRAM3
MEMORY CARD/SAVING DATA3
GAME CONTROLS4-5
SETTING UP THE GAME6
Select Game6
Exhibition6
Edit Starters7
Season8
Playoffs9
Draft11
Rosters12
Trade Players12
Create Players12
Release Players13
Sign Free Agents13
Reset Rosters14
Options14
Memory Card16
PLAYING THE GAME17
On-The-Fly Play Calling17
Pre-Game Menu17
Player Control18
Game Paused Menu18
Substitution19
Post-Game Menu20
ON THE COURT20
NBA SHOOTOUT '98 CREDITS23-24

PlayStation Setup

Console

Top View

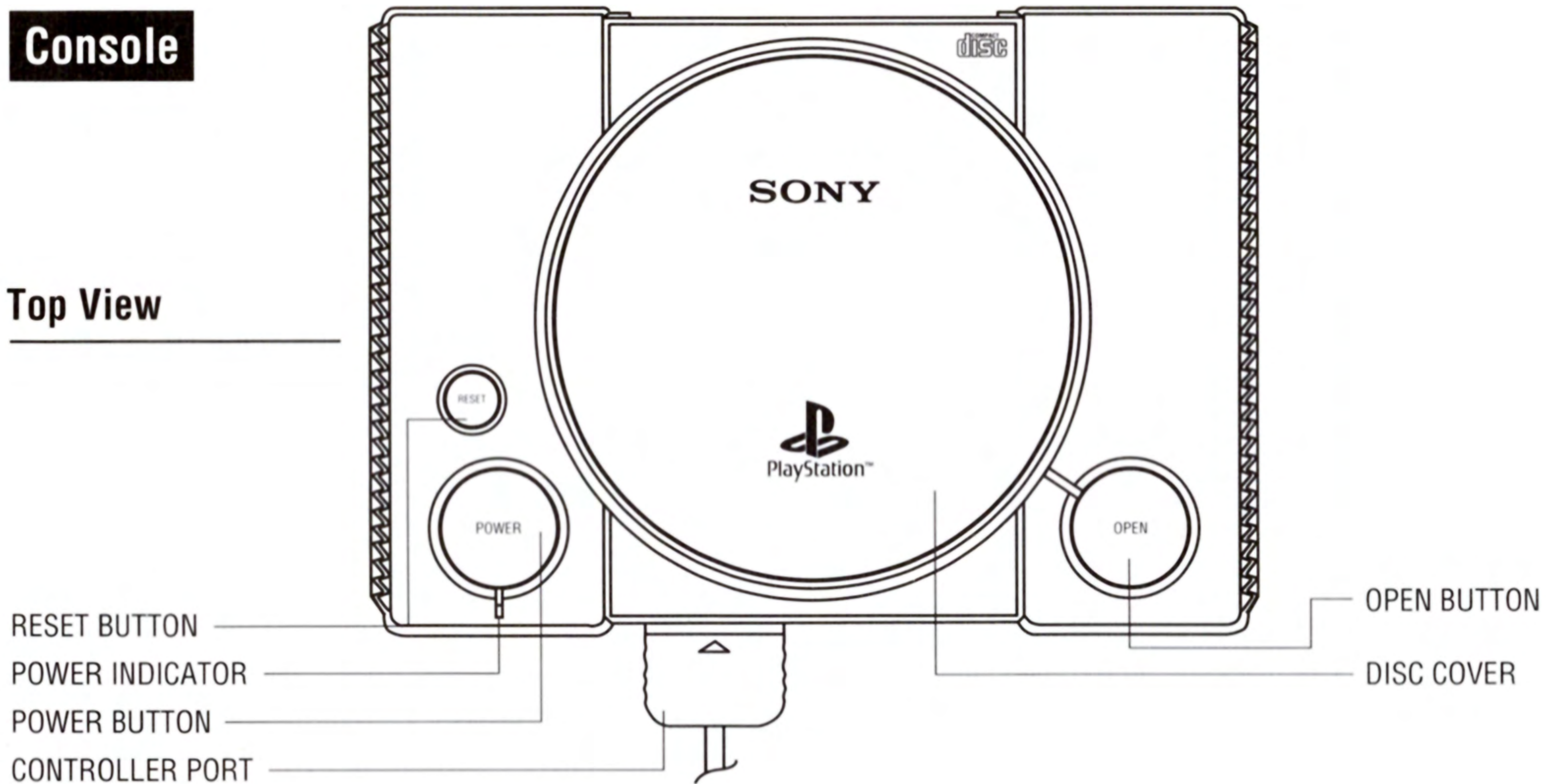

Front View

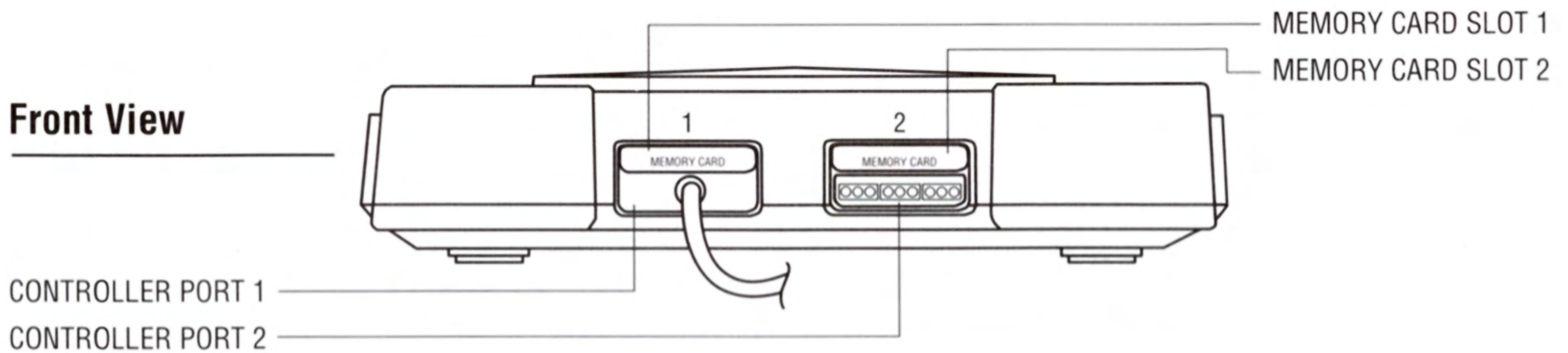

Set up your PlayStation™ game console according to the instructions in its Instruction Manual. Make sure the power is off before inserting or removing a compact disc. Insert the NBA ShootOut '98 disc and close the CD door. Insert game controllers and turn on the PlayStation™ game console. Follow on-screen instructions to start a game.

Controller Diagram

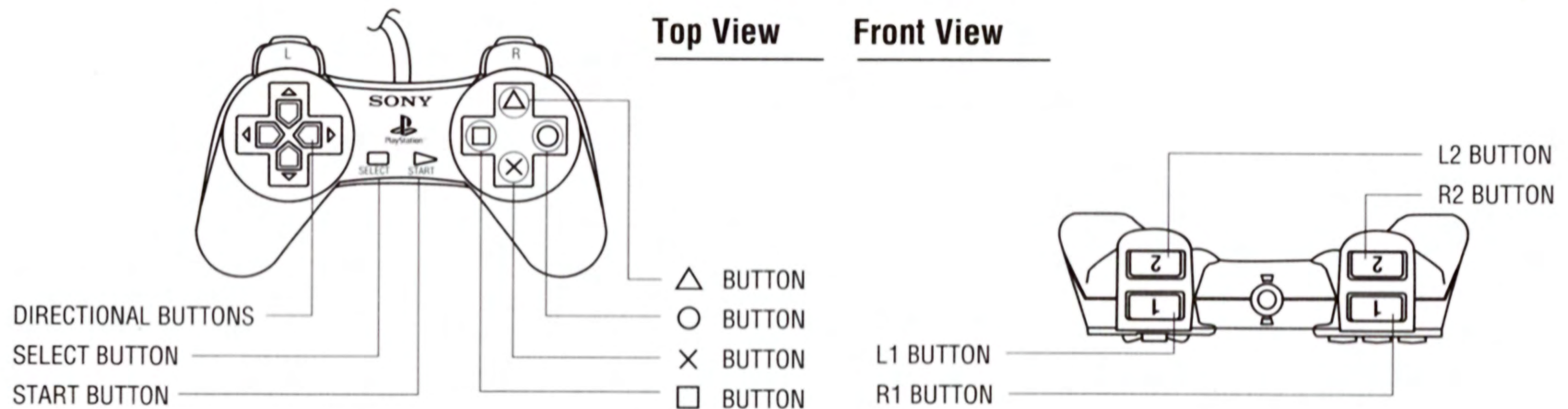

Memory Card/Saving Data

You must insert your Memory Card before you start a Season, Playoff, change a Roster, or Create a Player to save your progress. NBA ShootOut '98 saves user-defined options and all data for a Season, Playoff, Roster Change, or Created Player. Four blocks of memory must be available on your Memory Card in order to save any NBA ShootOut '98 data. Only one file can be saved at a time. If you don't have a Memory Card, all NBA ShootOut '98 data will be lost after turning off your PlayStation game console.

Game Controls

OFFENSE

⊗	Jump shot when stationary
⊗ + D-Pad away from basket	Fall-Away jumper
⊗ + D-Pad toward basket	Leaner
⊗ + R1	Hook shot
◻ + ⊗	Slam dunk. Runner if out of dunk range
○	Pass
⊗ then ○	Pass in mid-air
○ + △	Alley-Oop
◻ when stationary	Pump fake
◻ when moving	Turbo
△	Special move (dribble behind your back or between your legs)
R1 + D-Pad	Spin move
R1 when stationary	Backs player in towards basket
R2 + L2	Set screen
R1 + L1	Brings up offensive playbook icons

TOTAL CONTROL DUNKING

Take control of your dunk in mid-air by using Total Control Dunking™ (TCD). Press L1 to activate TCD then press one of the following controls or combinations to perform your favorite dunk.

L1	Activate TCD
⊗, ◻, △, ○, ◻ + ⊗, △ + ○	Dunk Types
◻ + ⊗	Follow up dunk off of missed shot
⊗	Tip in off of rebound

ICON CUTTING™

Allows you to direct any teammate to cut to the basket. Hold R2 to bring up the icons shown above each player. Send a cutter by pressing the button that corresponds with a teammate's icon.

R2	Brings up cutting icons
Icon	Player cuts. Double tap icon to pass to the cutter.

ICON PASSING™

Allows you to pass to any teammate. Hold L2 to bring up the icons shown above each player. Pass the ball by pressing the button that corresponds with a teammate's icon.

L2	Brings up passing icons
Double tap icon	Give and Go
Press icon then ⊗	Quick shot
Hold icon	Holds pass while you control the cutter. Release icon for cutter to receive pass.

DEFENSE



⊗	Steal
△	Rebound/Block shot
□	Turbo
○	Switch to defender closest to the ball
Hold ○	Switch to defender closest to the basket
L1 + ⊗	Intentional foul
L2	Switch to defender by icon
R2	Cherry pick
R1 + L1	Brings up defensive playbook icons.

ICON SWITCHING™

Switch manual control to any defensive player. Hold L2 to bring up the icons shown above each player. Switch control of a player by pressing the button that corresponds with a teammate's icon.

Setting Up The Game

MAIN MENU

From each menu, use the directional arrow pad (D-pad) to highlight the menu options. Press  to bring up the next menu and the  button to exit a screen and return to the previous menu.

SELECT GAME

EXHIBITION

Use Exhibition games to perfect your fundamentals and prepare yourself for a grueling regular season or the pressure of the playoffs. Exhibition games are not recorded in the season standings and cannot be saved to a memory card.

NOTE: Before starting a game, go to the Rosters and Options menus to make changes to your setup and game attributes.

TEAM SELECT SCREEN

Play with any team in the NBA including the Eastern and Western Conference All-Stars. Choose a team based on its league ranking in the nine categories shown.

- D-Pad Up/Down to view the offensive and defensive team rankings.

If you have altered a team's roster, press  to cycle through the rankings of the revised, original, and draft rosters.

- Press L1/L2 to cycle through the league and choose an Away team.
- Press R1/R2 to choose a Home team.
- Press  to accept the teams and bring up the Controller screen.



CONTROLLER

With the use of a Multi tap, NBA ShootOut '98 can be played with up to five players per team. A total of eight people can compete in a game.

- D-Pad Left/Right to choose a team. To play against the computer, leave the home or away controllers in their original state.
- Press  to bring up the Edit Starters screen.

EDIT STARTERS



Use this screen to edit the starting lineup for the game. Substitute a starter with a player off the bench or simply switch the players to different starting positions.

- D-Pad Left/Right to highlight a starter.
- Press  to bring up a list of available players at their usual positions.
- D-Pad Up/Down to select a player and press  to replace the starter.
- Press  to play the game.

HINT: Each team needs a player or “sixth man” to come off of the bench during the game and add some spark to his team. Usually, this player is your top reserve. Rather than substitute your best bench player for a starter at the beginning of the game, use him to come off the bench when you need a lift.

PLAYER CARDS

A player card holds valuable statistics and rankings of each player’s skill levels. See Definitions of Abbreviations below.

- Press  to view the Player Card of each starter or replacement.
- Press  to exit the Player Card.

DEFINITIONS OF ABBREVIATIONS

The following are definitions of the statistical abbreviations shown on a player card.

	OVR	Overall rating	
3PT	3-Point Shooting	DRB	Defensive Rebounding
OUT	Outside Shooting	PAS	Passing Ability
INS	Inside Shooting	BAL	Ball Control
FTH	Free Throw Ability	STL	Stealing
LAY	Lay-Up Skill	BLK	Shot Blocking Ability
OFF	Offensive Awareness	SPD	Speed
ORB	Offensive Rebounding	STA	Stamina
DEF	Defensive Awareness	CLU	Clutch Rating
DNK	Dunking Ability		

SEASON



See what it's like playing all of the teams from around the league in an entire NBA season. When a season is complete, if you're good enough, you'll have a chance to compete for the championship.

NEW SEASON

Select New Season and start your march through the regular season to a possible berth in the playoffs.

SEASON SCHEDULE

View the team schedules of every team in the league. From this screen, at any time during the season you can have a game simulated by pressing . All games prior to that date will be simulated for the entire league. To begin play in a new season:

- Press L1/R1 to cycle through the league and choose a team for the season.
- Press  to choose a roster.
- Press  to simulate a game(s).
- Press  to bring up the Controllers screen and play the next game on the schedule. See Controllers and Edit Starters under Exhibition for more details on setting up a game.

CONTINUE SEASON

Continue a season at the next scheduled game. Remember that games can be simulated. To use the Continue Season option, you must have already started a Season and saved the results to the Memory Card. If the PlayStation game console has been turned off, the season must be loaded prior to selecting this option. See Memory Card/Saving Data on page 3 for more details. Also, see Season for details on how to set up a season game.

TEAM STATS

See how each team stacks up to the rest of the league.

- D-Pad Up/Down to cycle through the entire list of teams.
- D-Pad Left/Right to cycle through the team ranking for each category.
- Press R2/L2 to cycle through stats for each team.

PLAYER STATS

View the season stats of each NBA player.

- Press R1/L1 to cycle through the teams.
- D-Pad Up/Down to cycle through the entire list of players.
- D-Pad Left/Right to cycle through the player ranking for each category.
- Press R2/L2 to cycle through stats for each player.

LEAGUE LEADERS

View the game-to-game rankings of the league's top 50 performers.

- D-Pad Up/Down to cycle through the entire list of players.
- D-Pad Left/Right to cycle through the player ranking for each category.
- Press R2/L2 to cycle through stats for each player.

STANDINGS

Check the game-to-game status of the league's standings.

- Press R1/L1 to cycle through divisions.
- D-Pad Left/Right to cycle through the team ranking for each category.
- Press R2/L2 to cycle through stats for each team.

AWARDS

View the season's top performers.

- D-Pad Up/Down to view the stats of each award winner.

PLAYOFFS





Bypass the regular season and jump straight into the playoffs. Two conference brackets make up 16 teams to compete for the coveted NBA Championship.

NEW PLAYOFFS

Customize the playoffs by setting up marquee matchups. Or, try to fix the brackets and games to simplify your team's road to the finals.



- D-Pad Left/Right to choose the Eastern or Western Conference bracket.
- D-Pad Up/Down to highlight a particular matchup.
- D-Pad Up/Down to highlight a team within the matchup.
- Press  to cycle through teams not set to participate in the playoffs.

When the teams have been set for each match:

- Press  to choose the playoff format.
- Press  to choose a “5-7-7-7” series format or “Single Elimination”.
- D-Pad Down and press  to choose a roster.
- Press  to bring up the Playoff Tree.



PLAYOFF TREE

The Playoff Tree screen shows the matchups for each round.

- D-Pad Left/Right to move through the Eastern and Western Conference brackets or press  to move from conference to conference.
- Press  to select a team.
- D-Pad Up/Down to highlight a game and Press  to bring up the Controller screen. You will be locked into this tier throughout the playoffs. See Exhibition for more details on setting up a game.

SIMULATE

From the Playoff Tree screen, each round of the playoffs can be simulated. For a Tournament Series, the first round is a “Best of Five” series. The next two rounds and the finals are “Best of Seven”.

- Press  to simulate a game.
- When you are ready to begin or resume play in a playoff game, press  to bring up the Controllers screen.

CONTINUE PLAYOFFS

Continue your run in the playoffs at the next scheduled game. To play in a continued playoff series, the playoffs must have been saved to the Memory Card and loaded prior to making this selection. You can also get to the playoffs by finishing a season.



NOTE: See Team Stats, Player Stats, League Leaders, and Standings under Season for more details on Playoff menu items.

DRAFT



Players are drafted at 5 positions (Point Guard - PG, Shooting Guard - SG, Small Forward - SF, Power Forward - PF, and Center - C). You can manually draft each position for up to 16 teams or have the computer hold the draft. The draft will go 5 rounds.

- Press  while the draft is taking place to view the starters of each team already taken.



To manually draft:

- D-Pad Up/Down, Left/Right to highlight a team.
- Press  to select the teams you would like to manually draft for.
- Press  to shuffle the draft order.
- Press  to start the draft.
- Press R1 to speed up the draft process.

You will be drafting one player for each position. When a team you have selected for manual drafting comes up in the draft order:

- Press  to choose a position to draft from.
- D-Pad Left/Right to cycle through the player ranking for each category.
- D-Pad Up/Down to choose a player still available in the draft.
- Press L2/R2 to cycle through his playing attributes.
- Press  to pick a player.

When the draft is complete:

- Press L1/R1 to cycle through the teams and view the drafted rosters.
- D-Pad Up/Down to view the entire roster of players.
- D-Pad Left/Right to cycle through the player ranking for each category.
- Highlight a player and press  to view his player card.
- Press  to reset rosters and begin the draft again.
- Press  to return to the Select Game screen and select a game type.

ROSTERS



The Rosters menu option gives you a chance to view and alter the entire player roster of every NBA team.

EDIT STARTERS

Use this screen to edit the starting lineup of any team. Substitute a starter with a player off the bench or simply switch the players to different starting positions. See Edit Starters under Exhibition for more details.

TRADE PLAYER





Build a dominant franchise and control the game on the floor by working a trade for that missing piece of a championship caliber team. Trade players to and from any team. Players can only be traded on a one-for-one basis.

- Press R1/L1 to choose a Home team.
- D-Pad Up/Down to highlight a player to trade.
- D-Pad Left to Away team.
- Press R1/L1 to choose an Away team.
- D-Pad Up/Down to highlight a player to trade.
- Press  to trade the players.
- Continue to trade players or press  to exit the screen.

NOTE: When a player is selected, press  to view his Player Card. Player Cards hold valuable player stats that can assist you in your decision to trade players.

CREATE PLAYER



Create an all-world basketball talent to take your team to the next level.

- D-Pad Up/Down to highlight the first name, last name, or college.
- Press  to bring up the alphanumeric chart.
- Use the D-Pad to highlight a letter or number and press  to enter it.
- To delete a letter or number, press .
- Spell out a name and press the  button to lock it in.

To continue to customize your player:

- D-Pad down to the other player attributes and D-Pad Left/Right to make a selection.

When you have completed the physical makeup of your player:

- Press  to alter you player's stats.
- D-Pad Up/Down to choose a player attribute.
- D-Pad Left/Right to raise or lower the skill levels of your player.
- Press  to create the player and bring up his player card. Your player has now been entered into the free agent pool.
- Press  to exit the Player Card and the Create Player screen.

NOTE: With only 720 points to distribute among the 19 categories, be wise in your allocation of each point to provide maximum efficiency for each player.



RELEASE PLAYER

Release any of the players on the current roster.

- Press L1/R1 to select a team.
- D-Pad Up/Down to highlight a player and press the  button to release him from the team roster and place him into the free agent pool.

SIGN FREE AGENT

You can only have 12 players per roster. To sign a free agent player, you must first release a player from your roster. Free Agents can also be signed when a player is released from the Release Player screen.

- D-Pad Right to choose a team to sign a Free Agent.
- Press L1/R1 to cycle through the league and select a team.
- If the team has a current roster of 12 players, D-pad Up/Down to highlight a player name and press  to release a player.
- D-Pad Left to choose a Free Agent.
- D-Pad Up/Down to highlight a Free Agent and press  to add the player to the team roster.

RESET ROSTERS

Rosters can easily be restored to their original setup.





- Press  to continue and reset all rosters. Choosing this option will also reset any season or playoffs not saved to the Memory Card.

OPTIONS

Use the options menu to further customize your game. Press  to toggle between the Game Options and Game Rules menus.

GAME OPTIONS

From the Game Options menu:

- Press  to cycle through the available settings.
- Press  to exit the screen and accept all settings.
- Press  to bring up the Game Rules menu to make other changes to rule settings. See below for Game Rule menu descriptions.
- If you prefer the original option and rule settings, press  to set all options back to the default settings.

GAME MODE (SIM/ARCADE)

Simulation mode best represents an NBA game. Player's fatigue and the rules of the NBA are closely followed. Arcade mode is loose and all out. Players can't foul out and never fatigue.

DIFFICULTY (ROOKIE/VETERAN/ALL-STAR)

The player difficulty will determine each player's offensive and defensive ability. To prepare yourself for the challenge of playing at the Veteran or All-Star levels, first master the Rookie level.

QUARTER LENGTH (2/3/4/6/9/12)

Choose one of the six available lengths in minutes of each quarter. There are four quarters per game.

TURBO (ON/OFF)

Turbo gives players some acceleration on the floor.

CLOSE SCORE (ON/OFF)

The computer will assist you in keeping games close and enabling you to come from behind to make a run at a last second victory.

PLAYER NAME (ON/OFF)

Each player designated by a controller will be identified during play.

DUNK REPLAYS (ON/OFF)

With Dunk Replays on, stop the replay by pressing START and then adjust the camera angle for a preferred view of the play.

COMMENTATOR (ON/OFF)

Turn the play-by-play commentator of the game on/off.

MUSIC (ON/OFF)

Keep Music on to hear music while navigating through the game setup screens.

SFX (ON/OFF)





Keep SFX on to hear the special sound effects of the game.

CROWD NOISE (ON/OFF)

Keep Crowd Noise on to hear the excitement of the crowd during the game.

GAME RULES

From the Game Rules menu:

- Press  to cycle through the available settings.
- Press  to exit the screen and accept all settings.
- Press  to go back to the Game Options menu if you need to make additional changes.
- Press  to set all options back to the default settings.

FOULS (NORMAL, AGGRO, NONE, FEW)

Set the occurrence of fouls called during a game. At a **Normal** setting, expect fouls to be called on a regular basis. A setting of **Aggro** will result in fouls being called frequently. A setting of **None** will result in no foul calls. A setting of **Few** will result in a limited number of foul calls.

FOUL OUT (2, 4, 6, 8, OFF)

Choose the number of fouls a player is allowed during the game. Or, turn this option off to allow a player an unlimited number of fouls.

BACKCOURT (ON/OFF)

Turn Backcourt off to allow a player to bring the ball into the backcourt after already bringing the ball over the mid-court line.

OUT OF BOUNDS (ON/OFF)

Turn Out Of Bounds off to use the full court for play. You can run out of bounds with the ball without being called for an infraction.

FATIGUE (ON/OFF)

Turn Fatigue off to keep your players from getting tired during play.

NOTE: The Player Name will begin to yellow as a player's fatigue increases.

3 SECOND VIOLATION (ON/OFF)

Turn this option off to allow your offensive players to camp in the key.

5 SECOND CLOCK

You must inbound the ball within 5 seconds or you will turn the ball over.

10 SECOND CLOCK

You must get the ball past the mid-court within 10 seconds of inbounding the ball or you will be called for a backcourt violation.

SHOT CLOCK (ON/OFF)

Keep the Shot Clock on to limit your time of possession to 24 seconds.

MEMORY CARD

The Memory Card allows you to Load, Save, or Delete files. To save a season or play-off game, from the Post-Game menu:

- Select Exit Game to return to the Main Menu.
- Select Memory Card and follow the on-screen instructions.

See Memory Card/Saving Data on page 3 for more details.

Playing The Game

ON-THE-FLY PLAY CALLING

Use On-The-Fly Play Calling to change your offensive and defensive sets during game play. To activate the offensive and defensive playbook icons:

- Press and hold L1 and R1 to view the playbook icons and press one of the following corresponding controls to set up a play.

- ⊙ **Inside Triangle** - Center and shooting guard play the perimeter.
- ⊠ **Box** - Center and power forward post up under the boards.
- ⊗ **Outside Triangle** - Shooting guard criss-crosses in the paint.
- ⊙ **Hi-Lo** - Positions the center hi and the power forward low.
- ⊗ + ⊠ **3-Point Play** - Isolates the shooting guard behind the arc.

- ⊙ **Half Court Press** - Defensive pressure after the ball crosses half court.
- ⊠ **Full Court Press** - Defensive pressure for the full length of the court.
- ⊗ **Double Team** - Double team the ball dribbler.

PRE-GAME MENU

Use the Pre-Game Menu to make any last minute changes to the game. See Options under Main Menu for repeated menu item descriptions.

START GAME

Select Start Game to begin play.

EDIT STARTERS

Edit your starting lineup before the tip.

- D-Pad Left/Right to select a position.
- D-Pad Up/Down to select a player.
- Press ⊙ to accept your changes and return to the Pre-Game menu.

PLAYER CONTROL

When two or more players select the same team, assign your controller to a player/position. From the Player Controls screen:

- Press ⊗ to bring up the players on the court.
- D-Pad Left/Right to set the controller to a different player.

DEFENSIVE MATCHUPS

Change the defensive matchups before the tip.

- D-Pad Up/Down to select a player for a matchup change and press ⊗.
- D-Pad Up/Down to select another player and press ⊗ to complete the switch.

When your defensive matchups are set, choose your defensive strategy.

- D-Pad Down and select Double Team.
- Press ⊗ to turn Double Team on/off. With defense set to double team, two players will defend the oppositions player. with the ball (L1+R1 + ⊗).
- D-Pad Down to Crash Boards and press ⊗ to turn Crash Boards on/off. With Crash Boards on, your team will be more aggressive in getting rebounds.

OFFENSIVE PLAYBOOK

View the game controls used for offensive play calling. See On-The-Fly Play Calling.

EXIT GAME

Quit the current game and return to the Main Menu.

GAME PAUSED MENU

Press the Start button to pause the game and bring up the following menu options. See Options and Pre-Game Menu for repeated menu item descriptions.

TIME OUT

Select this option to call a timeout. This will restore some energy to your team. Each team receives 7 timeouts per game.



- Press ⊗ from the timeout option to substitute a player or reset your defensive game plan.

SUBSTITUTION

Use this option to substitute a player off of the bench for anyone on the court.

- D-Pad Left/Right to select a player on the court.
- D-Pad Up/Down to choose a player to bring off of the bench.

To view a player's statistics:

- Highlight a player and press  to bring up his player card.
- Press  to exit the card.

REPLAY

To use replay:

L2	Rewind
R2	Play
L2 +R2	Slow-Motion replay
START	Set different camera angles
SELECT	Exit back to the game

GAME STATS

View the up to the minute team stats of the game.

PLAYER STATS

View the up to the minute player stats of the game.

- Press  to toggle between teams.
- D-Pad Left/Right to cycle through players.

CAMERA VIEW

One Player is the default view of the game. **Full Cover Low** is a full view of the game from a court level. **Full Cover Hi** is a top view of the game. **Up Court LR** is a view of the game from Left to Right. **Up Court RL** is a view of the game from Right to Left. Action Camera is a roving camera system that follows the play at unique angles.

EXIT GAME

Quit the current game and return to the Main Menu or start a rematch.

POST GAME MENU

Use this menu to check the stats of the completed game. See Game Paused Menu for repeated menu item descriptions.

REMATCH

Start another game between the same two teams.

PLAYER OF THE GAME

At the end of each game, the player who produced the biggest impact on the game will be showcased.

On The Court

PLAYER CONTROL

Each player manually controlled on the court is designated by a color circle. For example, Player 1 is marked by a player with a green circle. Player 2 is marked by a player with a red circle. Press  to give your player a turbo boost.



HALFTIME

At halftime, view the statistics and standouts from the first half.

- Press  to view the standouts.

HINT: At the end of each quarter, if one of your players is having matchup problems, take this opportunity to substitute a player. Press SELECT on your controller to bring up the Substitution screen. See Substitution under Game Paused Menu for more details.

JUMPBALL

When the ball is tossed up for the jumpball at the start of the game, press  or  to have your center jump for the tip. Use the D-Pad to aim the tip.

INBOUNDING THE BALL

Press  to inbound the ball. If there is a defender guarding the inbound pass, use the D-Pad to move the player inbounding the ball and pass the ball from a different angle.

HINT: If only a few seconds remain on the clock, increase your chances of getting a shot off before the buzzer by tapping ⊗ to switch the inbound pass to a player further down the court.

PASSING

Press ○ to pass the ball. The ball will be passed in the direction the passer is facing.

HINT: Long passes have a tendency to get picked off. Keep an eye on the defensive setup when attempting a long pass.

ICON PASSING

Icon Passing gives you complete control of your passing game, allowing you to pass the ball to any teammate on the court. Press L2 to bring up the passing icons.

ICON CUTTING

When you need to free a man up for a good look at the basket, press R2 and double tap the icon of a player to have him cut and then receive a pass close to the basket.

SHOOTING

For a jumpshot, hold ⊗ to jump, and then release it to shoot. Your chances of hitting the shot increase when you release the ball at the peak of the jump.

HINT: If a defender is in your face, while holding down ⊗ to shoot, press ○ before releasing the shot to pass off to the nearest teammate.

DUNKING



□ + ⊗ attempts a dunk or lay-up. If you press the dunk controls out of dunk range, the player will attempt a “leaner”. Use Total Control Dunking to choose a dunk style.

HINT: To perform a “follow up dunk” off of a missed shot, after taking the shot, position yourself for the board and press □ + ⊗ to slam it home. For an easy tip in off of a miss, press ⊗.

SPECIAL MOVES

Press △ to dribble between your legs, behind your back, or use a “cross-over dribble”. While dribbling up the floor, press R1 + D-Pad Left/Right to perform a spin move.

DEFENSE

Defense is man-to-man and the computer controls the defenders not under manual control. To take control of the defender closest to the player with the ball, press . Press and hold  to activate the man closest to the basket.

HINT: Use Icon Switching on defense to control your favorite player. Like Icon Passing, Press L2 to bring up the switching icons shown above each player. Once the icons are up, press the button that corresponds with the defender you would like to switch to.

SHOT BLOCK

Time your leap and press  to attempt to block a shot.

REBOUNDING

Read the angle of the shot to get in the best position for the rebound. Box other players out and press  to time your jump and get the board.

STEALING

Press  to check the ball handler and reach for the ball to attempt a steal.

HINT: Leave the man you're guarding to double-team the player with the ball and attempt a steal. Be sure to watch for a pass to the player you left unguarded.

FREE THROWS

When you get fouled in the act of shooting, you will be sent to the free throw line to shoot foul shots. Two bars will appear on the screen to help with your aim.

- Press  again to stop the cursor directly in the intersection of the two bars.

NOTE: If you wait more than five seconds the computer will take over and attempt the shot for you by stopping the cursor.

When you stop the horizontal cursor, the vertical cursor begins moving.

- Press  to stop the vertical cursor at the intersection of both bars. If you succeed in stopping both cursors at or near the center of each bar, the free throw attempt will be successful.

NBA SHOOTOUT '98 CREDITS

PROGRAMMERS

Geoff Goldberg, Fred Shic and Bob Skinner

ARTISTS

Andrei Booriakin, Mike Bolger and John Settles

SENIOR PRODUCER

Chris Cutliff

ASSISTANT PRODUCER

Algon Leighton

DIRECTOR OF SPORTS DEVELOPMENT

Kelly Ryan

SENIOR DIRECTOR, PRODUCT MARKETING

Peter Dille

SENIOR PRODUCT MANAGER, MARKETING

Craig Ostrander

ASSISTANT PRODUCT MANAGER, MARKETING

Allan Frankel

MARKETING COORDINATOR

Ed Loonam

SENIOR CREATIVE SERVICES MANAGER

Howard Liebeskind

SOUND AND MUSIC

Rex Baca, Chuck Carr, and Joel Copen

MOTION CAPTURE STUDIO

Dwayne Mason, Brian Johnson, Jason Parks, and Dominic Perricone

MOTION CAPTURE ATHLETE

Jerry Stackhouse

VIDEO

Scott McMahon

DOCUMENTATION AND LAYOUT

David Lovalvo

TEST MANAGER

Charles Flock

LEAD TESTERS

Eddy Cramm, Masashi Ogasawara and Walter McDowell

TESTERS

Brad Spilkin, Chris Mitzlaff, Doug Damron, Bryan Anderson, Jose Araiza, Jeff Bolaris, Charles Brown, Cavan Bunting, Marc Frodsham, Mike Gallina, Robbie Helsel, Minoh Kim, Josh Liberty, Orion Slevin and Paul Tutko

SPECIAL THANKS

Vin Baker, Greg Lassen, Kaz Hirai, Kelly Flock, Andrew House, Jack Tretton, Jeff Fox, Frank O'Malley, Marilyn Weyant, Terri Rago, Riley Russell, Jean Galli, Heidi Adams, Donna Armentor, Shelley Ashitomi, Maggie Baquero, Kim Bardakian, Gary Barth, Mike Benton, Christa Carter, Lori Chase, Chris Clark, Joyce Clement, Bruce Cochrane, Tina Cruz, Steve Dreo, Jason Torres, Brian Dimick, Aimee Duell, Tim Duzmal, Ron Eagle, Christy Favrhov, Matt Feyling, Butch Freedhoff, Peggy Gallagher, Bob Gayman, Randy Gordon, David Greenspan, Kerry Hopkins, Kevin Horn, Kim Hornecker, Jeff Hutchinson, Eric Ishii, Mike Janis, Chris Johnson, Genie Kim, Kelly Loyd, Nikki McGrath, Colin MacLean, Quinn Pham, Renee Middleton, Liz Miranda, Joel Pambid, Mark Pentek, Phil Rosenberg, Kevin Seiter, Sharon Shapiro, Helene Sheeler, Maggie Silverman, Molly Smith, Yvonne Smith, Wendy Spander, Jason Torres, Kris Trathen, Nemer Velasquez, Michelle Vercelli, Michelle Whitmer, and B.D. Fox.

SOFTWARE WARRANTY

Sony Computer Entertainment America (SCEA) warrants to the original purchaser of this SCEA product that this Game Pak is free from defects in material and workmanship for a period of ninety (90) days from the original date of purchase. SCEA agrees for a period of ninety (90) days to either repair or replace, at its option, the SCEA product. You must call 1-800-345-SONY to receive instructions to obtain repair/replacement services.

This warranty shall not be applicable and shall be void if the defect in the SCEA product has arisen through abuse, unreasonable use, mistreatment, or neglect. THIS WARRANTY IS IN LIEU OF ALL OTHER WARRANTIES AND NO OTHER REPRESENTATIONS OR CLAIMS OF ANY NATURE SHALL BE BINDING ON OR OBLIGATE SCEA. ANY IMPLIED WARRANTIES APPLICABLE TO THIS SOFTWARE PRODUCT, INCLUDING WARRANTIES OF MERCHANTABILITY AND FITNESS FOR A PARTICULAR PURPOSE, ARE LIMITED TO THE NINETY (90) DAY PERIOD DESCRIBED ABOVE. IN NO EVENT WILL SCEA BE LIABLE FOR INCIDENTAL OR CONSEQUENTIAL DAMAGES RESULTING FROM POSSESSION, USE OR MALFUNCTION OF THE SCEA SOFTWARE PRODUCT.

Some states do not allow limitations as to how long an implied warranty lasts and/or exclusions or limitations of consequential damages, so the above limitations and/or exclusions of liability may not apply to you. This warranty gives you specific legal rights, and you may also have other rights which vary from state to state.



EXCLUSIVE

PlayStation



MLB 99



UNPRECEDENTED GRAPHICS

► Over 140 new, personalized moves and stances of MLB™ pitchers and batters. See homeplate collisions, batters celebrate after home runs, fielders make barehanded pick ups and throws, and players getting progressively dirty after diving catches and slides and more! All the subtle moves of the Big Leagues!

REAL PLAYER ATTRIBUTES

► All players scaled to actual height and weight with names and numbers on their jerseys. Each player's skills are based on their actual stats.

REVOLUTIONARY SPRING TRAINING MODE

► Create and play players to see if you have what it takes to get to the SHOW. Player's performance (hitting, pitching, fielding and throwing) determines your fate with your favorite team.

MLB™ AUTHENTICITY

► Legendary Vin Scully describes all of the action. Stadium specific ambiance like the waterfalls in Kansas City and fireworks in Seattle. Real awards like the Cy Young™, MVP and more!



AVAILABLE APRIL



MLB and The Major League Club insignias depicted on this product are trademarks which are the exclusive property of the respective Major League Clubs and may not be reproduced without their written consent. Major League Baseball trademarks and copyrights are used with permission of Major League Baseball Properties, Inc. Official Licensee - Major League Baseball Players Association. © MLBPA. Developed by Sony Interactive Studios America. © 1998 Sony Computer Entertainment America Inc.

NBA ShootOut, the NBA and individual NBA Team identifications used on or in this product are trademarks, copyrighted designs and other forms of intellectual property of NBA Properties, Inc. and the respective member Teams and may not be used, whole or in part, without the prior written consent of NBA Properties, Inc. © 1998 NBA Properties, Inc. All rights reserved. Icon Passing is a trademark of Sony Computer Entertainment America Inc. Developed by Sony Interactive Studios America. © 1998 Sony Computer Entertainment America Inc.

Sony Computer Entertainment logo is a trademark of Sony Corporation. PlayStation and the PlayStation logos are trademarks of Sony Computer Entertainment Inc. The ratings icon is a trademark of the interactive Digital Software Association. Manufactured and printed in the U.S.A. THIS SOFTWARE IS COMPATIBLE WITH PLAYSTATION GAME CONSOLES WITH THE NTSC U/C DESIGNATION U.S. AND FOREIGN PATENTS PENDING.



SONY



COMPUTER ENTERTAINMENT